



DOMINA PRO 700 - ELEMENTS NEUTRES

**N74T**



## TOP

### SPÉCIFICATIONS TECHNIQUES:

Dimensions exterieure - LxPxH (cm)	40x73x25
Tiroir	<input type="checkbox"/>

### SPÉCIFICATIONS SUPPLÉMENTAIRES:

Poids (kg)	18
Volume (m3)	0,2

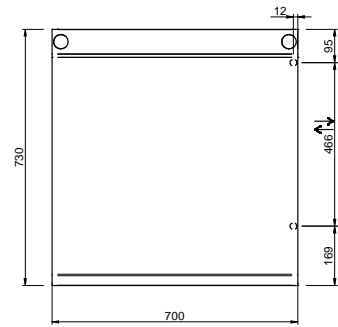
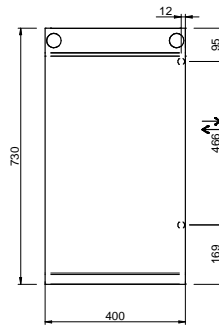
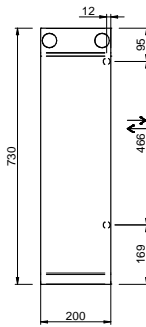
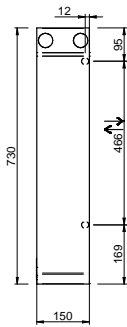
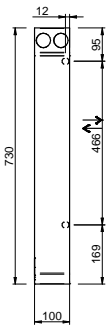
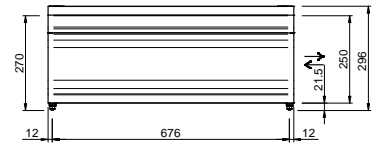
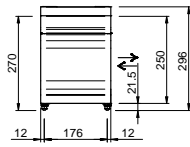
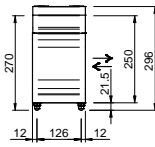
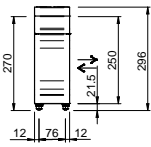

LEGENDA SIMBOLI / LEGEND



INGRESSO GAS / GAS INLET  
(EN 10226-1) Ø M 1/2"



ALIMENTAZIONE ELETTRICA /  
POWER SUPPLY



INGRESSO ACQUA /  
WATER INLET Ø M 1/2"



SCARICO ACQUA / OLII  
WATER / OILS DRAIN



ATTACCO EQUIPOTENZIALE /  
EQUIPOTENTIAL



REGOLAZIONE PIEDINI /  
FEET ADJUSTMENT (h 0/+50)  
/ TOP VERSION (h 0/+5)